



Volvo Trucks. Driving Progress



# **VOLVO OVERHAUL AND POWERTRAIN PARTS UPDATE**

Look inside for information on new programs and tools to help you quote, sell and profit.

**SEPTEMBER 2016**

# VOLVO GUARANTEED OVERHAUL

We built it. We can overhaul it.

New kits to make the in-frame job complete!

## Volvo Overhaul Installation Kit

Description	Part Number
D11 EPA07	85145681
D11 EPA10	85145682
D11 EPA14	85149912
D12D EPA02/04	85145873
D13 EPA07	85145689
D13 EPA10	85145684
D13 EPA14	85149913
D16 EPA04	85145691
D16 EPA07	85145692
D16 EPA10	85145686
D16 EPA14	85149914

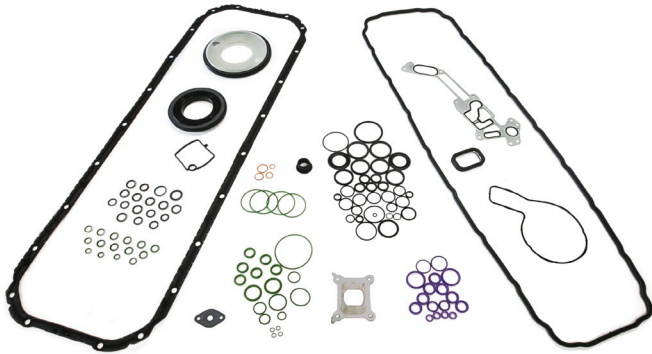

## Volvo Reman Loaded Cylinder Overhaul Kit

Description	Part Number
D11 EPA07	85146672
D11 EPA10	85146672
D11 EPA14	<i>Coming soon!</i>
D12D EPA02/04	85125020
D13 EPA07	85145689
D13 EPA10	85146683
D13 EPA14	<i>Coming soon!</i>
D16 EPA04	85146687
D16 EPA07	85146687
D16 EPA10	85145686
D16 EPA14	<i>Coming soon!</i>

## Volvo Supplementary Out-of-Frame Kit

Description	Part Number
D11 EPA 07	20882498
D11 EPA10	21442804
D11 EPA14	22521911
D13 EPA07	85148924
D13 EPA10	85148924
D13 EPA14	22522116
D16 EPA04	85148925
D16 EPA07	85148925
D16 EPA10	85148925
D16 EPA14	22521734

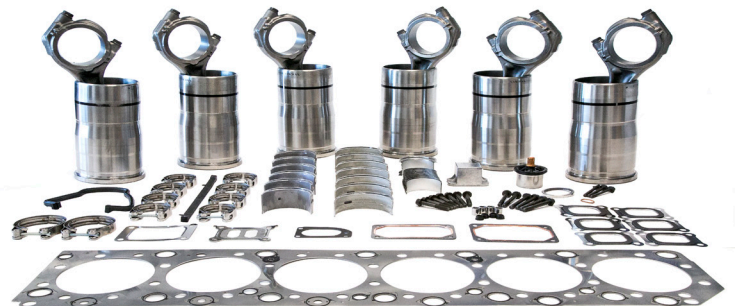

# VOLVO OVERHAUL PROMOTIONS

## Volvo Reman Loaded Cylinder Installation Tool

Description	Part Number
D11	88800556
D12/D13	88870026
D16	88800557

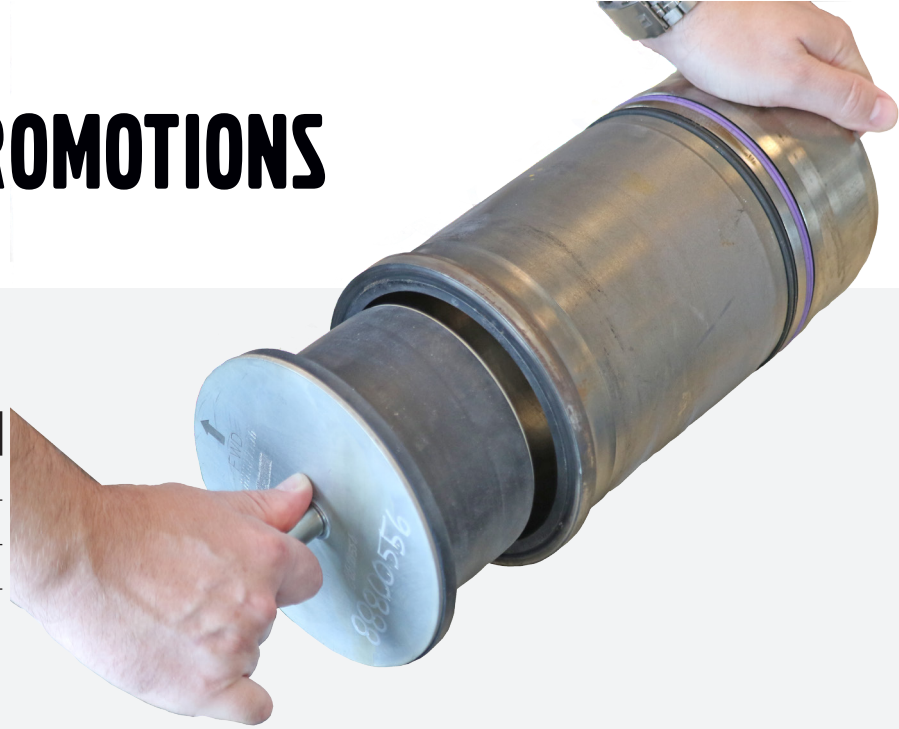

## Volvo Reman Loaded Cylinder Installation Tool Promotion

For a limited time, Volvo will provide a credit towards the purchase of a Loaded Cylinder Installation Tool for the first 50 dealers that order a Volvo Loaded Cylinder Overhaul Kit. The tool allows for easier installation of Loaded Cylinder assembly, saving time during the overhaul. Visit the Reman section of Trucks Dealer Portal and click on the “D12/D13 Volvo Reman Loaded Cylinder Kit Installation Tool - Free” bulletin (5/24/2016).

## Double Idler Gear Labor Promotion

Volvo Trucks will pay for up to 10 hours of dealership labor at your approved warranty labor rate to cover the incremental variable cost to install the Double Idler Gear during Premium Level 3 Overhauls. Repair order must indicate purchase of updated idler gear and indicate credit was passed to customer. Visit the Volvo Guaranteed Overhaul section of Trucks Dealer Portal and click on the “Overhaul with Double Idler Gear Promotion” bulletin (4/6/2016).

Description	Part Number
D11	21826609
D13	21826610
D16	21826611

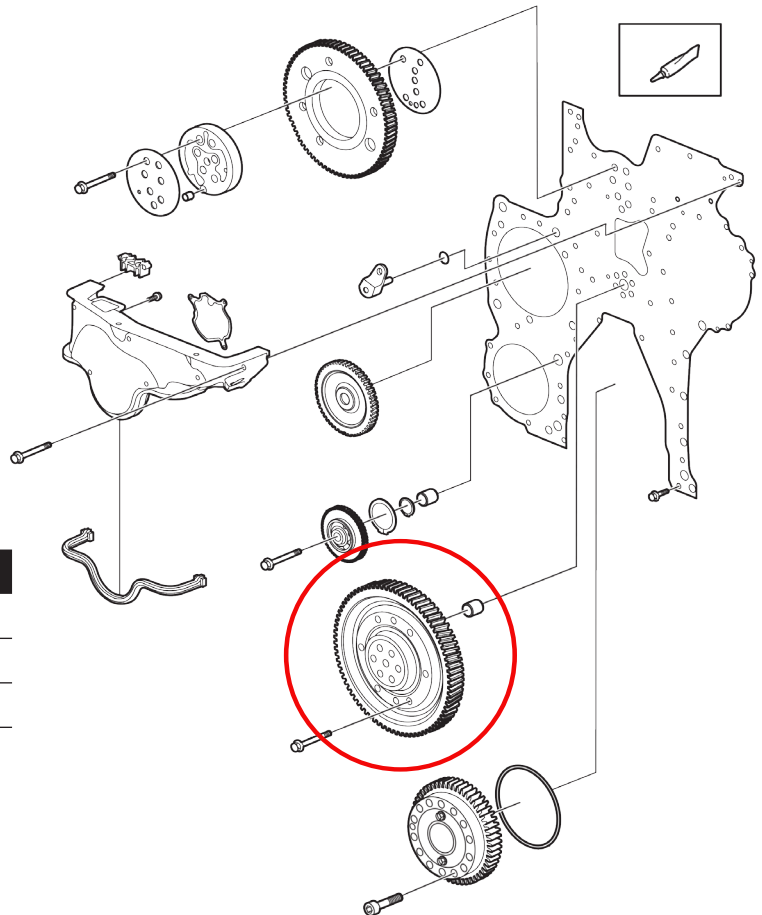

# NEW OVERHAUL QUOTE CALCULATOR

## Be ready for the Overhaul customer!

The new Volvo Overhaul Quote Calculator is now the best place to start when pricing Volvo Guaranteed Overhauls. The new calculator is located on Trucks Dealer Portal>Parts>Programs>Volvo Guaranteed Overhaul.

The new calculator is:

- In an easy-to-use, web-based format
- Always updated with current pricing and part numbers
- Customizable to all customers
- Works on all internet-ready devices, perfect for Outside Parts Sales



Please contact [brandon.page@volvo.com](mailto:brandon.page@volvo.com) if you have any issues accessing the Overhaul Quote Calculator.

### Overhaul Marketing and Reference Materials



» downloadable overhaul hotsheets and part number reference guides

### Overhaul Bulletins



» latest news about the Volvo Guaranteed Overhaul program

### Warranty Documents



» overhaul registration forms for 3 year/350K mile warranty

### Engine Overhaul Training Videos



» click here to view engine overhaul training videos

### Overhaul Quote Calculator - CA



online tool for Volvo Canadian dealers to calculate customer price and overhaul profitability

### Overhaul Quote Calculator - US



online tool for Volvo US dealers to calculate customer price and overhaul profitability

## Volvo Engine Overhaul Quote Summary

**Customer Name:** John Smith

**Engine:** D13 US10

### Summary

Part Description	Level 1 - Basic	Level 2 - Plus	Level 3 - Premium	Level 4 - Reman Engine
Inframe Overhaul Kit	\$4,554.90	\$4,554.90	\$4,554.90	N/A
Volvo Reman Cylinder Head	N/A	\$3,381.00	\$3,381.00	N/A
Volvo Reman Turbo Kit	N/A	N/A	\$2,833.98	\$2,833.98
Volvo Reman 6-Pack Injector	N/A	N/A	\$2,247.16	N/A
Volvo Reman 3/4 Basic Engine	N/A	N/A	N/A	\$20,222.78
Volvo Genuine Filter Kit	\$88.98	\$88.98	\$88.98	\$88.98
Volvo Genuine Coolant Filter	\$6.96	\$6.96	\$6.96	\$6.96
Volvo Premium Oil	\$0.00	\$0.00	\$0.00	\$0.00
Volvo Premium Coolant	\$0.00	\$0.00	\$0.00	\$0.00
Parts	\$4,650.83	\$8,031.83	\$13,112.97	\$23,152.69
Labor	\$150.00	\$150.00	\$150.00	\$150.00
Installed	\$4,800.83	\$8,181.83	\$13,262.97	\$23,302.69

**Volvo Truck Dealer**  
123 Volvo Way  
Any City, VA 12345  
123-456-7890

**Expiration Date:** 12/31/2016  
**Currency:** USD

# VOLVO REMAN EPA14 BASIC (3/4) ENGINES ARE NOW AVAILABLE!

Part Number	Application
85020376	D11J EPA14/OBD15/OBD16 with Engine Brake, utilizing flywheel housing P/N 20955388 or 22417822. (Flywheel housing total width of 204mm/8.03"). Mechanical and Allison transmission applications. Services 22288147, 22573337
85020380	D11J EPA14/OBD 15/OBD16 with Engine Brake, utilizing flywheel housing P/N 20955334 or 22417820. (Flywheel housing total width of 179mm/7.05"). I-Shift transmission applications. Services 22288149, 22573343
85020405	D13J EPA14/OBD15/OBD16 with Engine Brake, utilizing flywheel housing P/N 20575963, 20926829, 21424703, 21063851 or 21347407. (Flywheel housing total width of 179mm/7.05"). I-Shift transmission applications. Services 22289225, 22573519
85020407	D13J EPA14/OBD15/OBD16 with Engine Brake, utilizing flywheel housing P/N 21424704, 21547051 or 21347406. (Flywheel housing total width of 184mm/7.24"). Mechanical transmission applications. Services 22289228, 22573521
85020415	D16J EPA14/OBD15/OBD16 applications. Services 22291927, 22575194

## Volvo Reman Basic (3/4) Engine Installation Kit

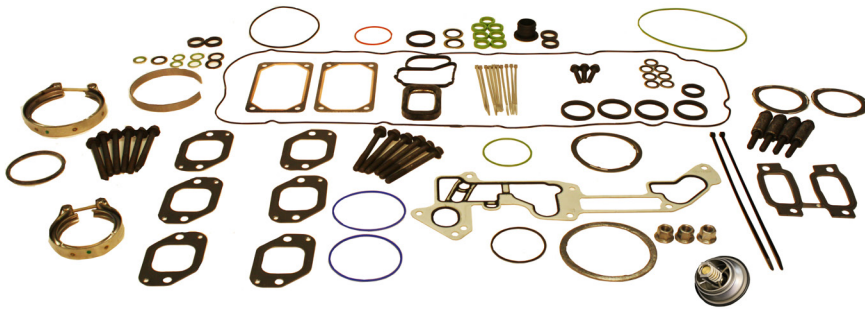

Description	Part Number
D11F EPA07	85148972
D11H EPA10	85148975
D11J EPA14	85148978
D13F EPA07	85148973
D13H EPA10	85148976
D13J EPA14	85148979
D16F EPA07	85148974
D16H EPA10	85148977
D16J EPA14	85148980

# VOLVO REMAN FLEET SPEC 7/8 ENGINES



Volvo Reman 7/8 engines have all the VIN-specific components, less the starter and alternator. Volvo Reman now has several fleet spec 7/8 engine applications. Contact Rick Cape or Jeffrey Burrow for information and ordering.

Model	Description
RT85001164	D12D, no engine brake, electric fuel pump primer, 365, 395, 435 HP
RT85001219	D12D, no engine brake, mechanical fuel pump primer, 365, 395, 435 HP
RT20982244	D13F EPA07 with engine brake, Allison and I-Shift applications, services 20982246, 85001621
RT20982248	D13F EPA07 with engine brake, mechanical transmission, services 20982248, 85001622
RT21729914	D13H EPA10 with engine brake, mechanical transmission, services 21729914, 85003655

# VOLVO REMAN I-SHIFT TRANSMISSION

## Reman Options

### COMPLETE



- **Dyno tested under load**
- **Installation-ready**
- **Latest updates**

### BASIC

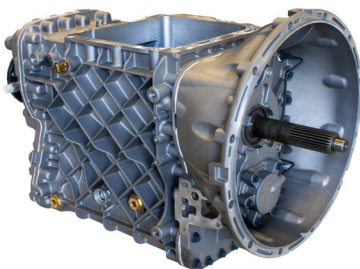

Same as Reman I-Shift Complete, less:

- **Top shift cover**
- **CCA**
- **CCV**
- **TECU**

### SHORT

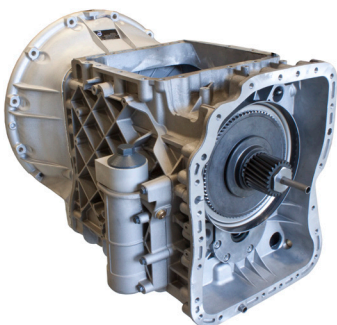

Same as Reman I-Shift Basic, less:

- **Auxiliary Range Section**

#### Volvo Reman I-Shift Complete

Model	Part Number	Warranty
<b>STANDARD</b>		
AT2512C	85003144	2 Years/Unlimited Miles
ATO2512C	85003145	2 Years/Unlimited Miles
ATO3122C	85003147	2 Years/Unlimited Miles
AT2612D	85020580	2 Years/Unlimited Miles
ATO2612D	85020581	2 Years/Unlimited Miles
ATO3112D	85020582	2 Years/Unlimited Miles
<b>HD</b>		
AT2612D-HD	85020349	2 Years/Unlimited Miles
ATO2612D-HD	85020350	2 Years/Unlimited Miles

#### Volvo Reman I-Shift Basic

Model	Part Number	Warranty
<b>STANDARD</b>		
AT2512C	85013417	2 Years/Unlimited Miles
ATO2512C	85013419	2 Years/Unlimited Miles
ATO3112C	85013421	2 Years/Unlimited Miles
AT2612D	85013431	2 Years/Unlimited Miles
ATO2612D	85013433	2 Years/Unlimited Miles
ATO3112D	85013435	2 Years/Unlimited Miles
<b>HD</b>		
AT2612D-HD	85020435	2 Years/Unlimited Miles
ATO2612D-HD	85020436	2 Years/Unlimited Miles
ATO3112D-HD	85020755	2 Years/Unlimited Miles

#### Volvo Reman I-Shift Short

Model	Part Number	Warranty
<b>STANDARD</b>		
AT2512C	85013418	1 Year/Unlimited Miles
ATO2512C	85013420	1 Year/Unlimited Miles
ATO3112C	85013422	1 Year/Unlimited Miles
AT2612D	85013432	1 Year/Unlimited Miles
ATO2612D	85013434	1 Year/Unlimited Miles
ATO3112D	85013436	1 Year/Unlimited Miles
<b>HD</b>		
AT2612D-HD	85020422	1 Year/Unlimited Miles
ATO2612D-HD	85020443	1 Year/Unlimited Miles
ATO3112D-HD	85020756	1 Year/Unlimited Miles

# VOLVO REMAN ENGINE AND TRANSMISSION KITS AND COMPONENTS

## Volvo Reman I-Shift Range Section Kit



- Kit Contains:**
- High Range Drum
  - Spacer Ring
  - Snap Rings
  - Speed Sensor
  - Output Flange

### Reman I-Shift Range Section 1 Year/Unlimited Miles

Model	Part Number
AT2512C, ATO2512C, ATO3112C, AT2612D, ATO2612D, ATO3112D	85020424

## Volvo Reman EPA14 Injector and Six-Pack Kit

Single Injector	Part Number
D11J EPA14	85020426
D13J EPA14	85020428
D16J EPA14	85020430
Injector Six-Pack	Part Number
D11J EPA14	85144516
D13J EPA14	85144518
D16J EPA14	85148520



## Volvo Reman EGR Valves



Part Number	Applications
85020219	11L and 13L to current/EPA07 through EPA14 Services 85133799

# PTO, PUMP AND ACCESSORY PROGRAMS

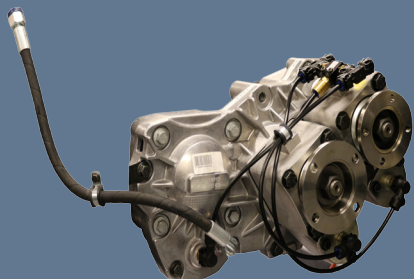

Volvo offers a full line of Volvo Genuine, Muncie and Chelsea-Parker PTOs, pumps, wetline kits and accessories to upgrade any application to a more vocational machine.

Muncie VDSP - MUN

Chelsea VDSP - CHL

Parker VDSP - PH0

*For PTO application technical support, call 877-770-7575.*

# VOLVO OVERHAUL AND POWERTRAIN PARTS UPDATE

## For more information contact:

### **BRANDON PAGE**

Powertrain and Overhaul Product Manager  
Volvo Trucks

Phone 336-708-4632

Email [brandon.page@volvo.com](mailto:brandon.page@volvo.com)

### **JEFFREY BURROW**

Reman Marketing Development Manager  
Volvo Trucks

Phone 336-215-2865

Email [jeffrey.burrow@volvo.com](mailto:jeffrey.burrow@volvo.com)

### **RICK CAPE**

Reman Technical Product Manager  
Volvo Trucks

Phone 336-508-3668

Email [richard.cape@volvo.com](mailto:richard.cape@volvo.com)



7900 National Service Rd.  
Greensboro, NC 27409